

# NO LIMITS – with 6 Pin around the world

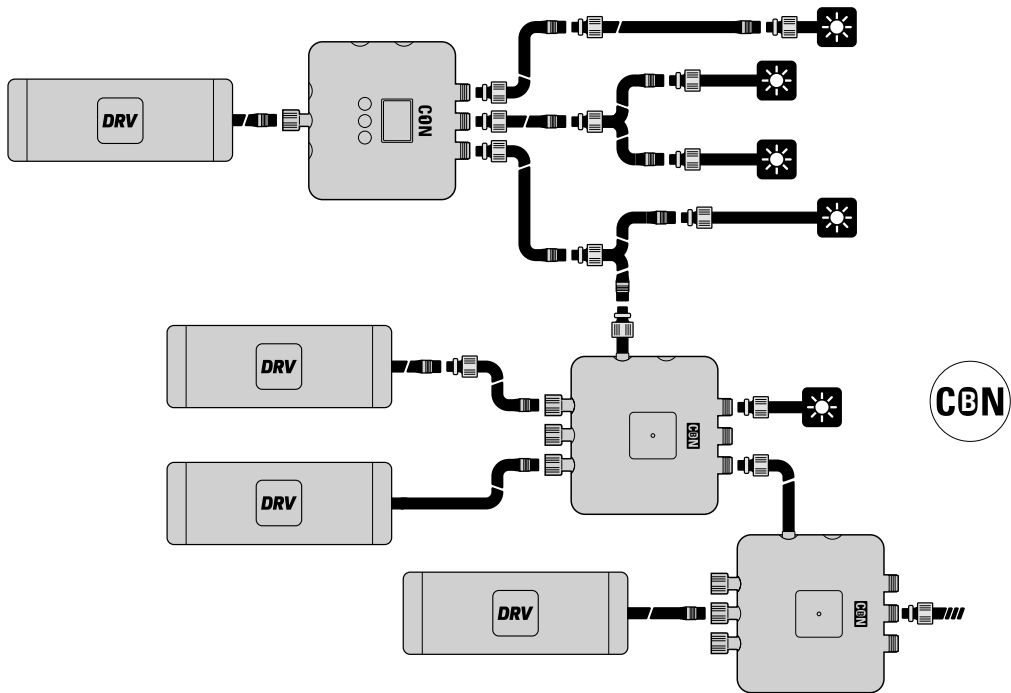

## MAX 4x6Pin connections



# Four simple steps

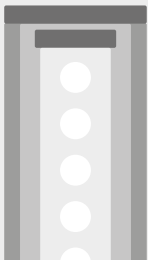

**1** Choose the SunStrip

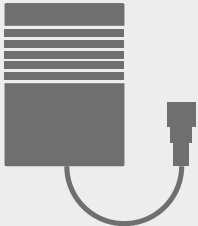

**2** Choose the Driver



**3** Choose the Holder



**4** Choose the Control



## **CON** Link examples for CON

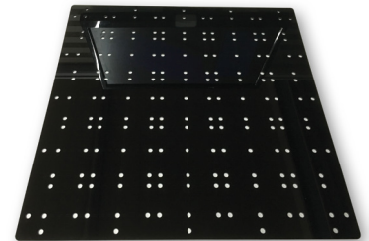
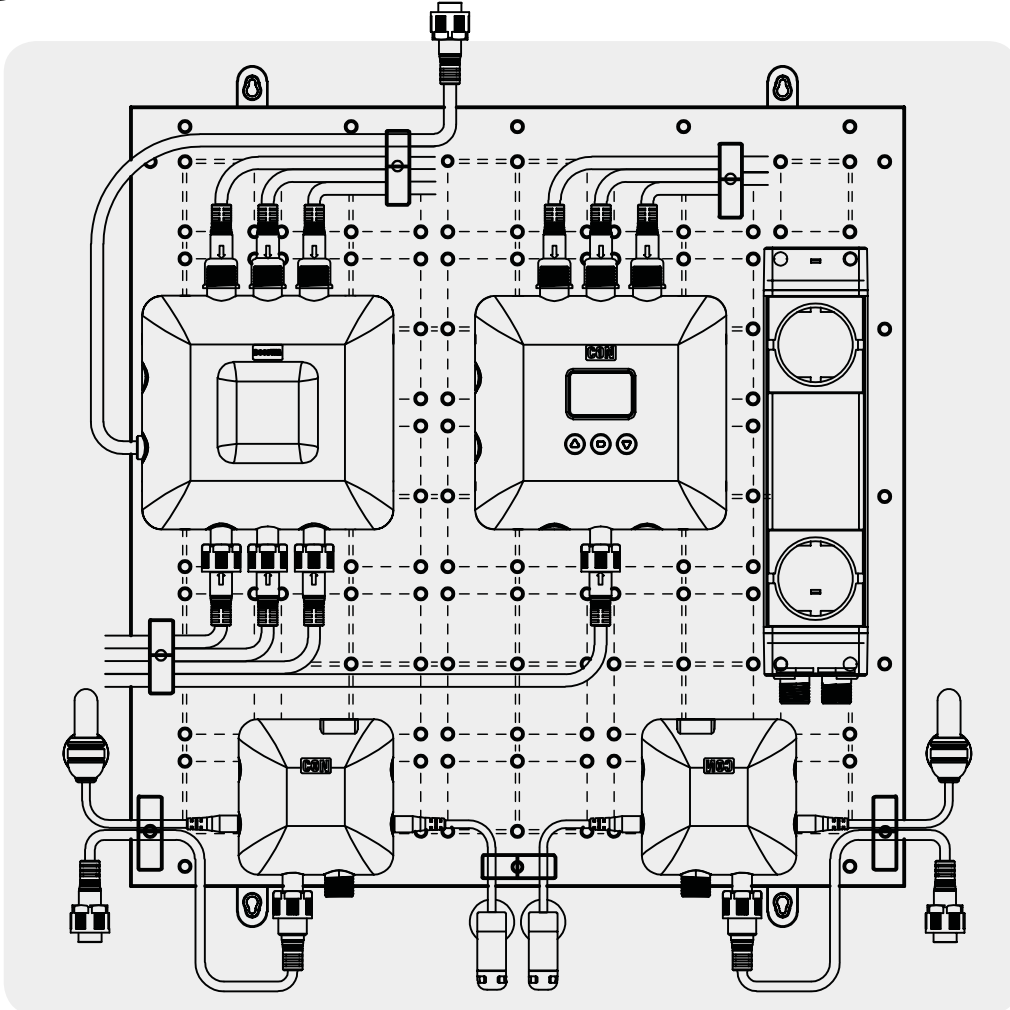

### **GridPlate**

40x60cm/15,75x23,62in grid plate to connect all CON products with cable management systems.

### **GridPlate-Holder**

